

NC-82 Series 3-1/4" Thermal Terrace Doors

Product Details - Inswing Terrace Door w/ Side Lite and Transom



Note: Multiple configurations of this window system are available. Refer to the WINCO website for additional options or contact your local WINCO Sales Representative for information.

WINCO RESERVES THE RIGHT TO MODIFY OR CHANGE INFORMATION WITHIN THIS BOOK WHEN DEEMED NECESSARY FOR PRODUCT IMPROVEMENT

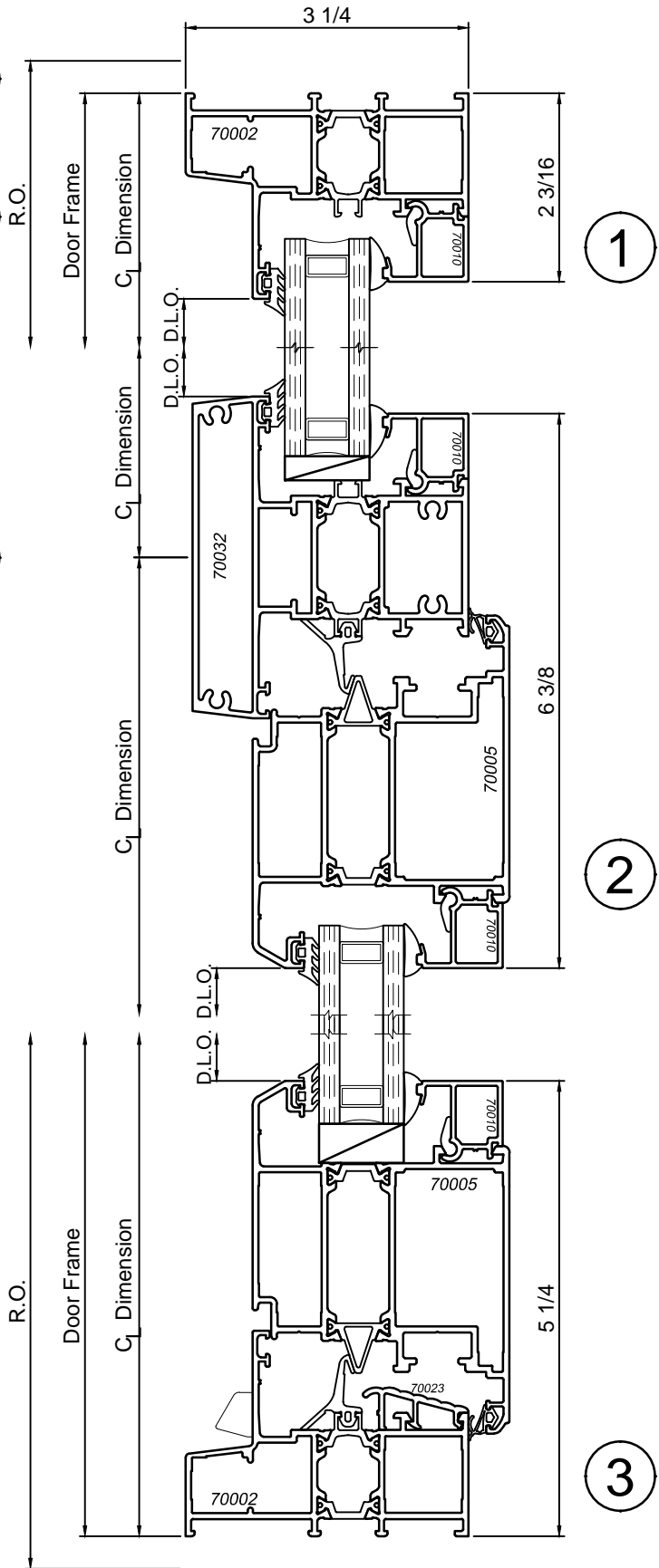
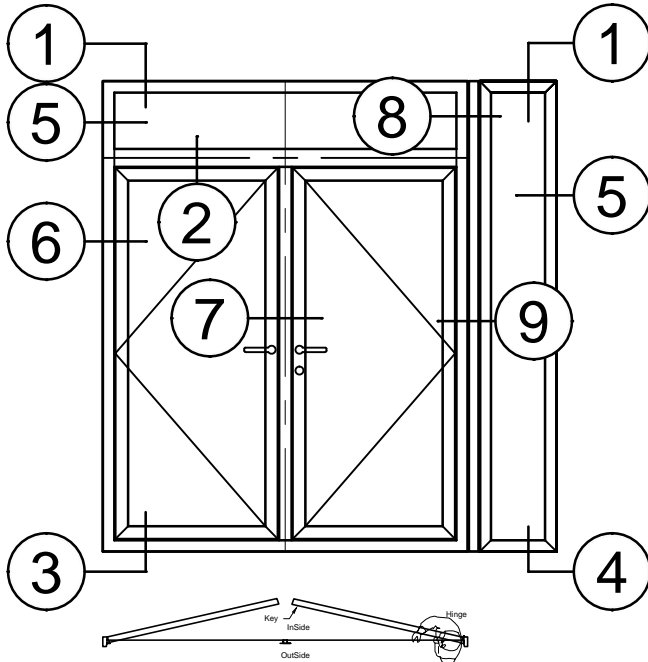

© WINCO WINDOW COMPANY, INC. 2016

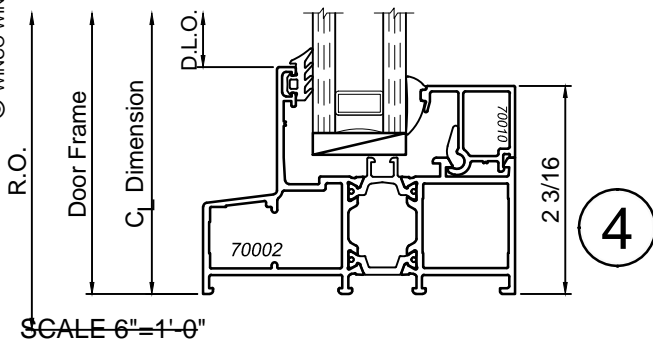

SCALE 6"=1'-0"

NC-82 Series 3-1/4" Thermal Terrace Doors

Product Details - Inswing Terrace Door w/ Side Lite and Transom



Note: Multiple configurations of this window system are available. Refer to the WINCO website for additional options or contact your local WINCO Sales Representative for information.

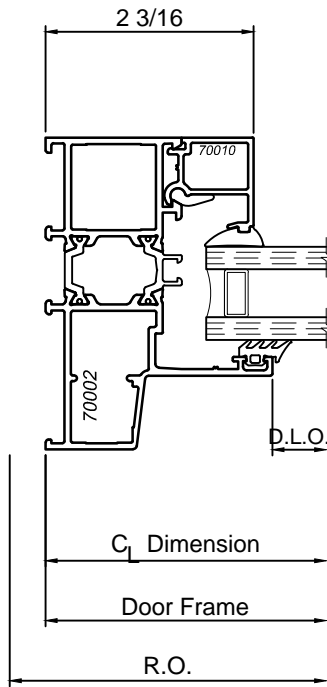

5

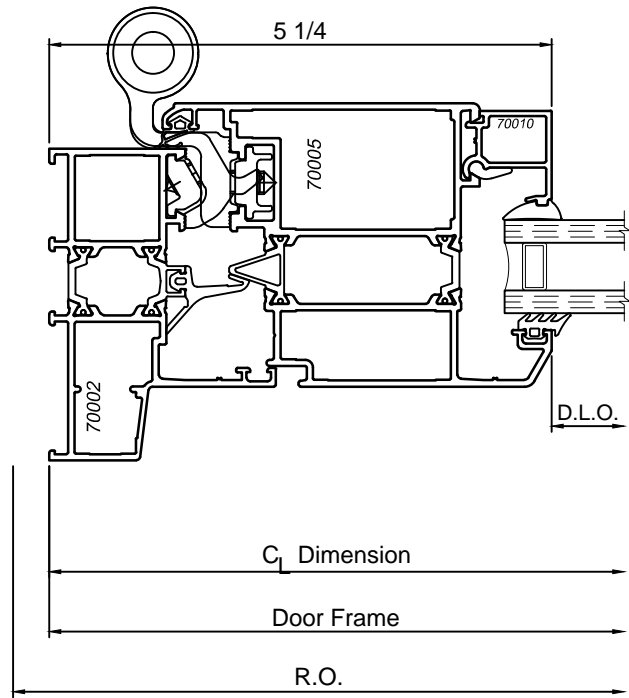

6

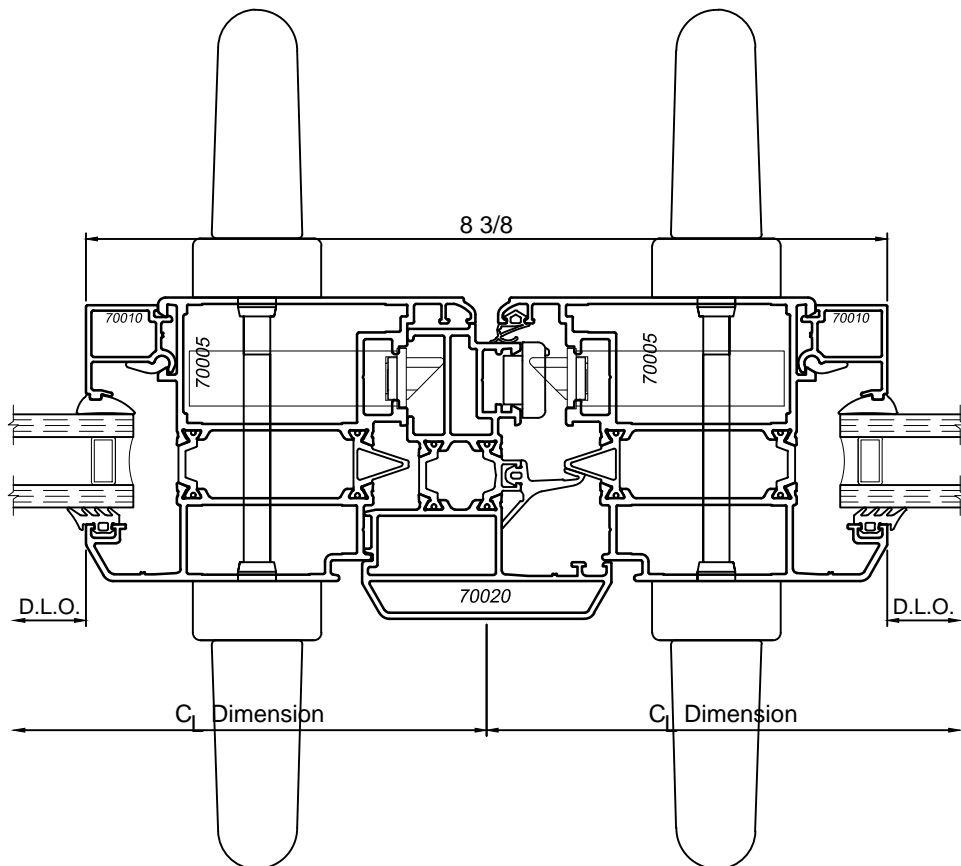

7

WINCO RESERVES THE RIGHT TO MODIFY OR CHANGE INFORMATION WITHIN THIS BOOK WHEN DEEMED NECESSARY FOR PRODUCT IMPROVEMENT

© WINCO WINDOW COMPANY, INC. 2016

SCALE 6"=1'-0"

NC-82 Series 3-1/4" Thermal Terrace Doors

Product Details - Inswing Terrace Door w/ Side Lite and Transom



Note: Multiple configurations of this window system are available. Refer to the WINCO website for additional options or contact your local WINCO Sales Representative for information.

WINCO RESERVES THE RIGHT TO MODIFY OR CHANGE INFORMATION WITHIN THIS BOOK WHEN DEEMED NECESSARY FOR PRODUCT IMPROVEMENT

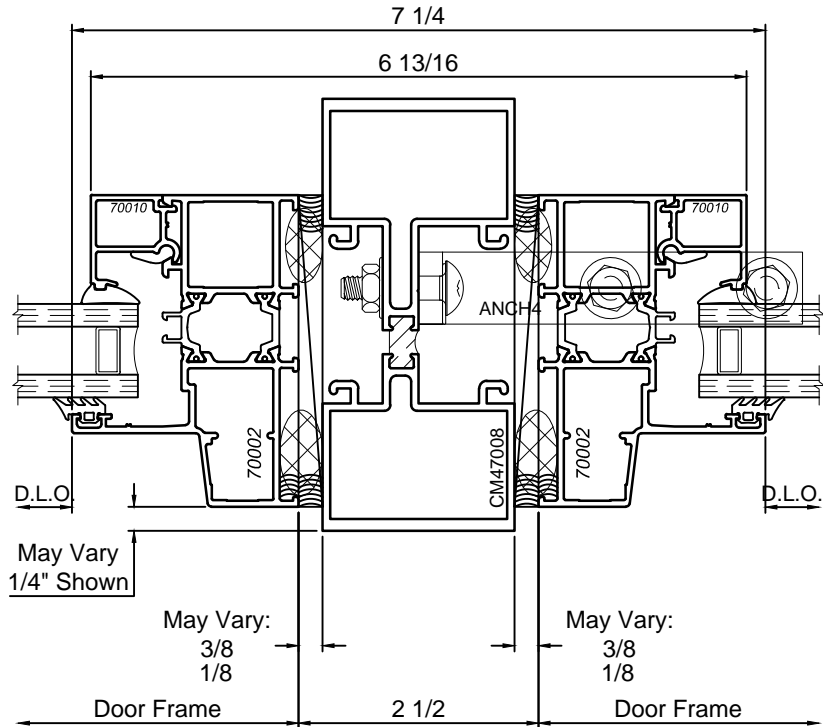

8

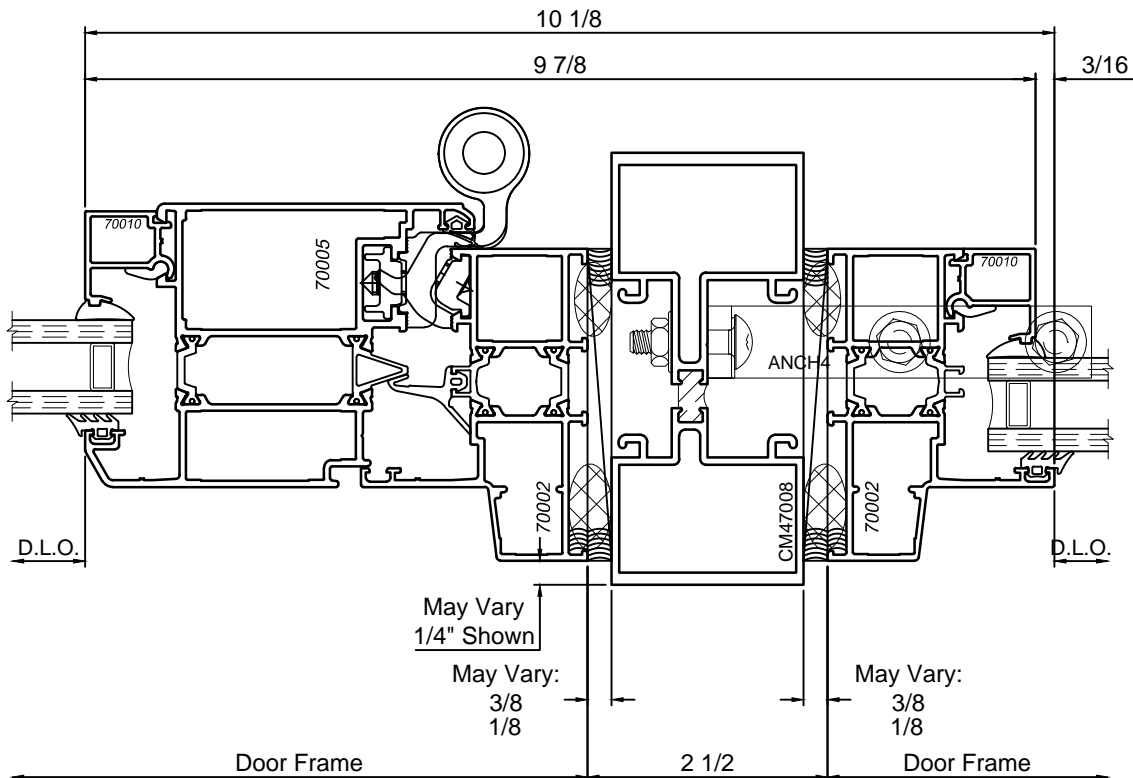

9

SCALE 6"=1'-0"