

1150S Series 2" Thermal Fixed, Casement & Projected Windows

Product Details - Inswing Casement



Note: Multiple configurations of this window system are available. Refer to the WINCO website for additional options or contact your local WINCO Sales Representative for information.

WINCO RESERVES THE RIGHT TO MODIFY OR CHANGE INFORMATION WITHIN THIS BOOK WHEN DEEMED NECESSARY FOR PRODUCT IMPROVEMENT

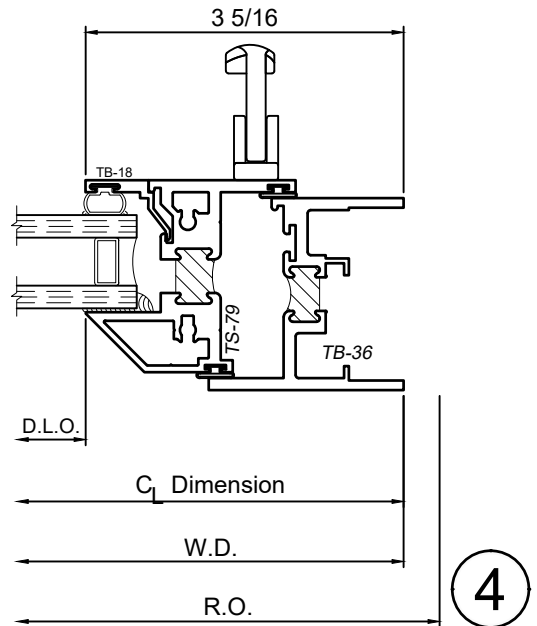
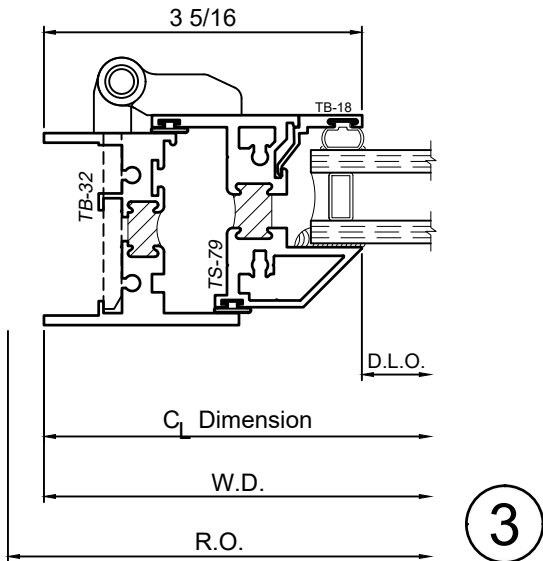
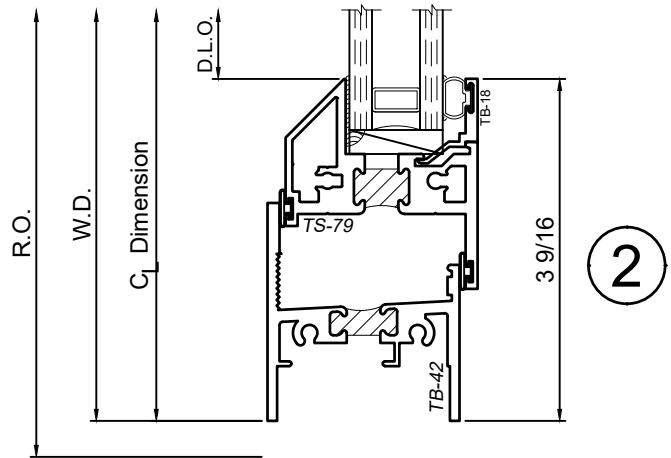
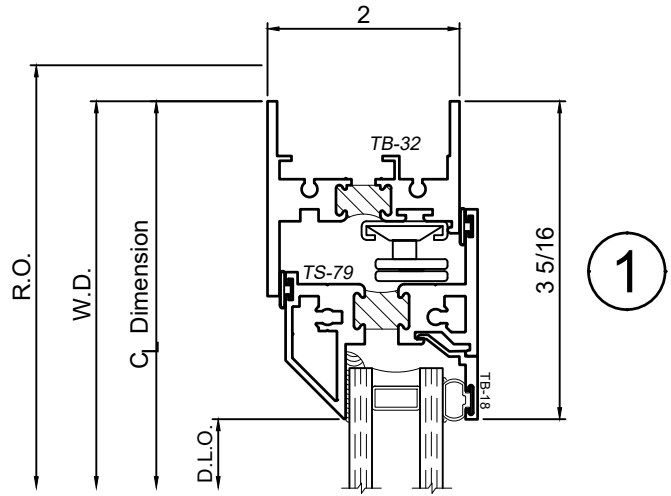
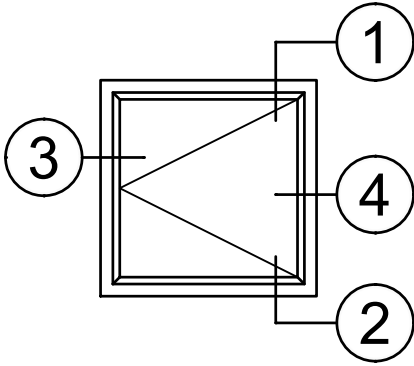

© WINCO WINDOW COMPANY, INC. 2021

SCALE 6"=1'-0"