

1450S Series 4" Thermal Fixed, Casement & Projected Windows

Product Details - PO|PI - Awning|Hopper

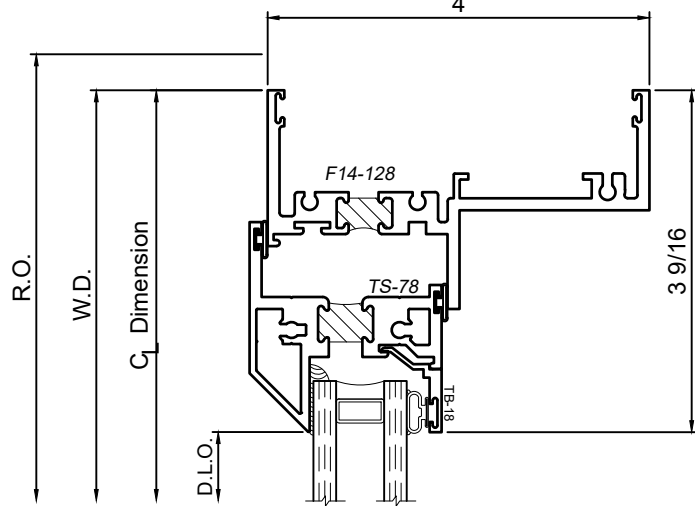

Note: Multiple configurations of this window system are available. Refer to the WINCO website for additional options or contact your local WINCO Sales Representative for information.

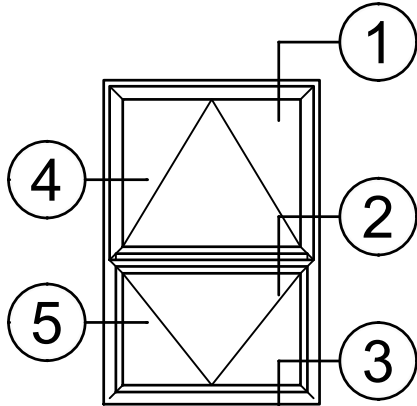

1

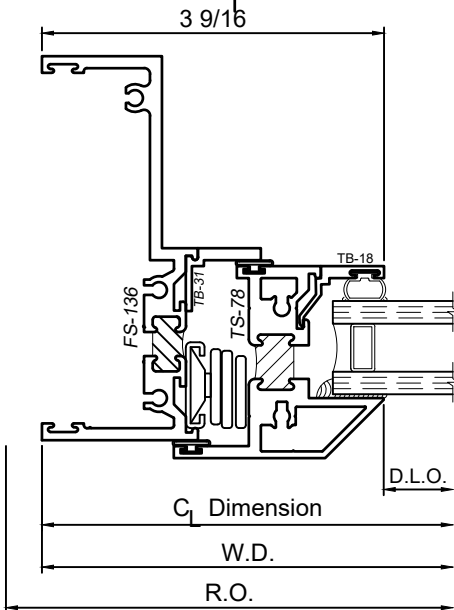

4

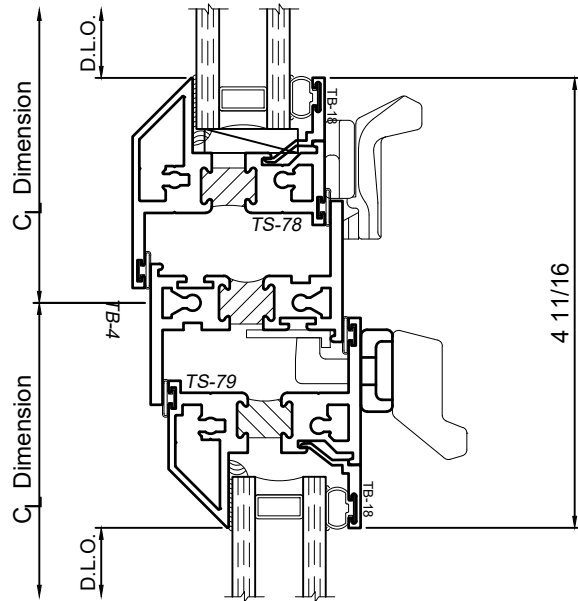

2

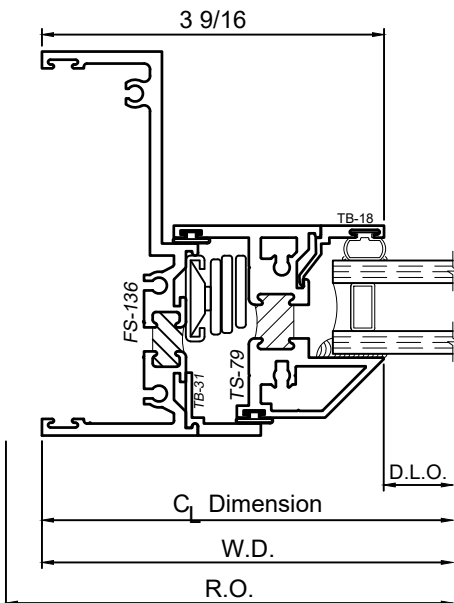

5

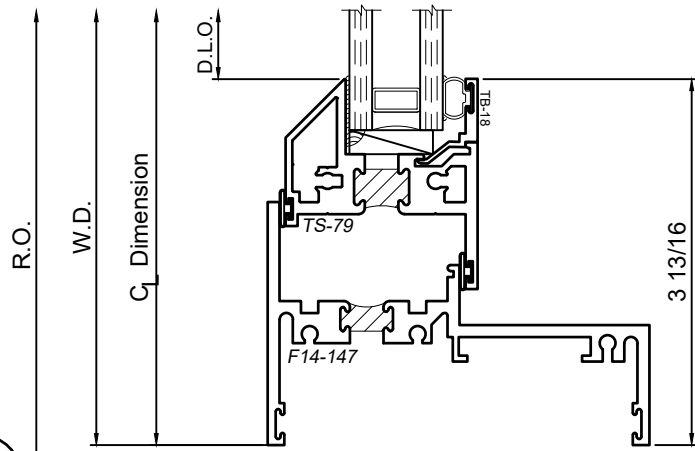

3

WINCO RESERVES THE RIGHT TO MODIFY OR CHANGE INFORMATION WITHIN THIS BOOK WHEN DEEMED NECESSARY FOR PRODUCT IMPROVEMENT

© WINCO WINDOW COMPANY, INC. 2020

SCALE 6"=1'-0"