

3350 Series 3-1/2" Thermal Fixed, Casement & Projected Windows

Product Details - Butterfly Casement - Outswing



Note: Multiple configurations of this window system are available. Refer to the WINCO website for additional options or contact your local WINCO Sales Representative for information.

WINCO RESERVES THE RIGHT TO MODIFY OR CHANGE INFORMATION WITHIN THIS BOOK WHEN DEEMED NECESSARY FOR PRODUCT IMPROVEMENT

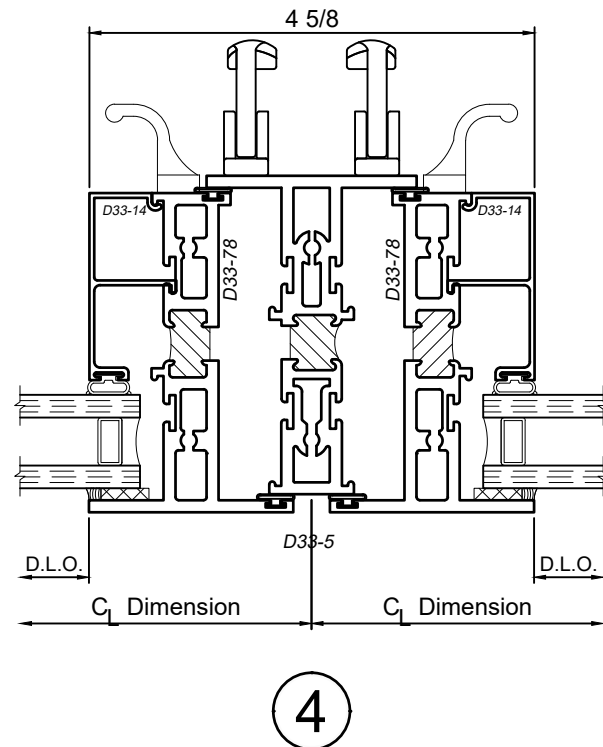
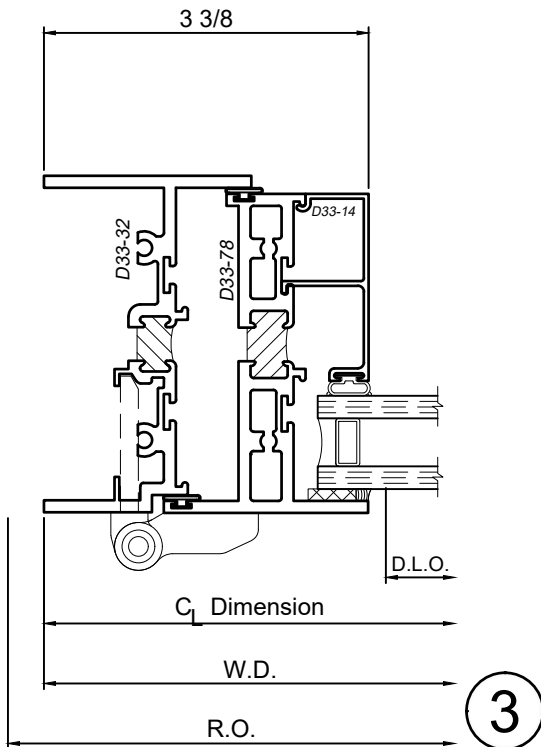
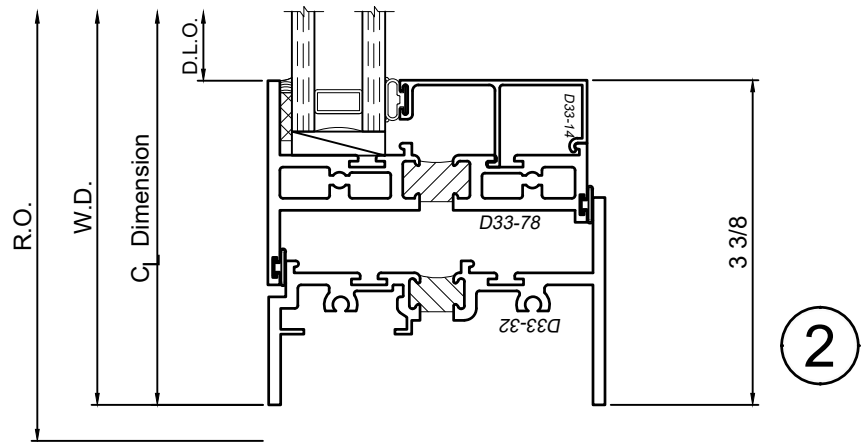
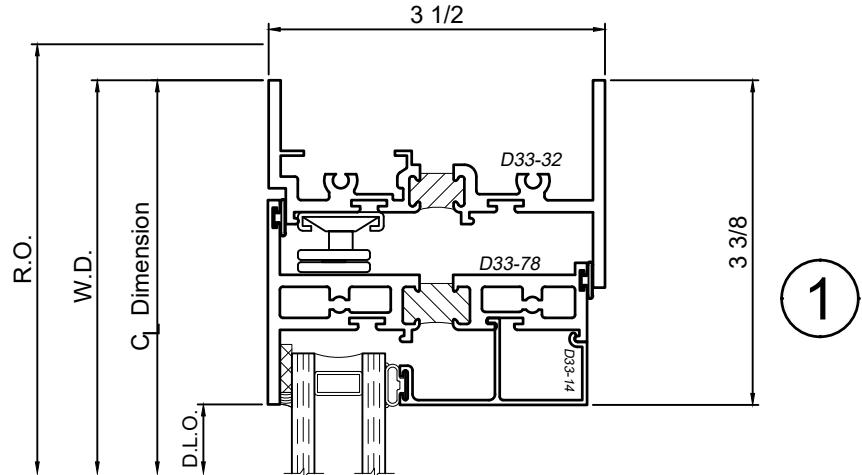
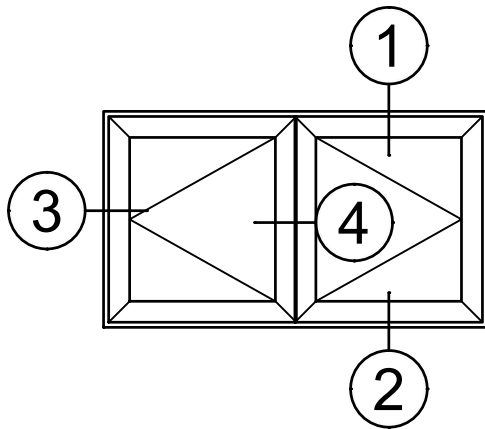

SCALE 6"=1'-0"

© WINCO WINDOW COMPANY, INC. 2021