

4" Thermal Hung Replica and Slider Replica Windows

Product Details - Fixed over PI [HR-12]



Note: Multiple configurations of this window system are available. Refer to the WINCO website for additional options or contact your local WINCO Sales Representative for information.

WINCO RESERVES THE RIGHT TO MODIFY OR CHANGE INFORMATION WITHIN THIS BOOK WHEN DEEMED NECESSARY FOR PRODUCT IMPROVEMENT

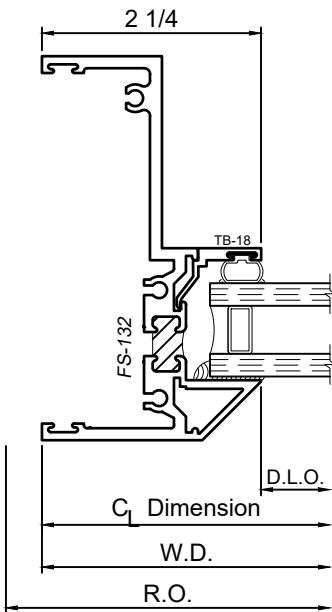
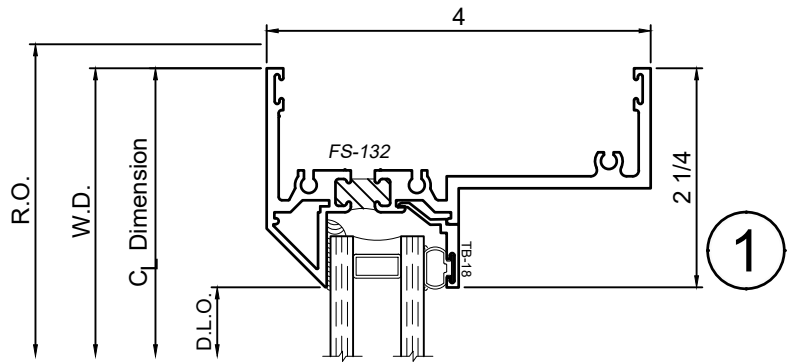
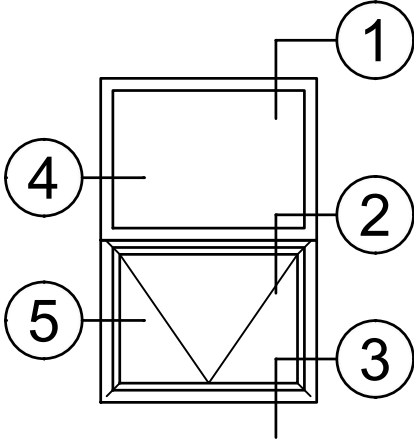

4

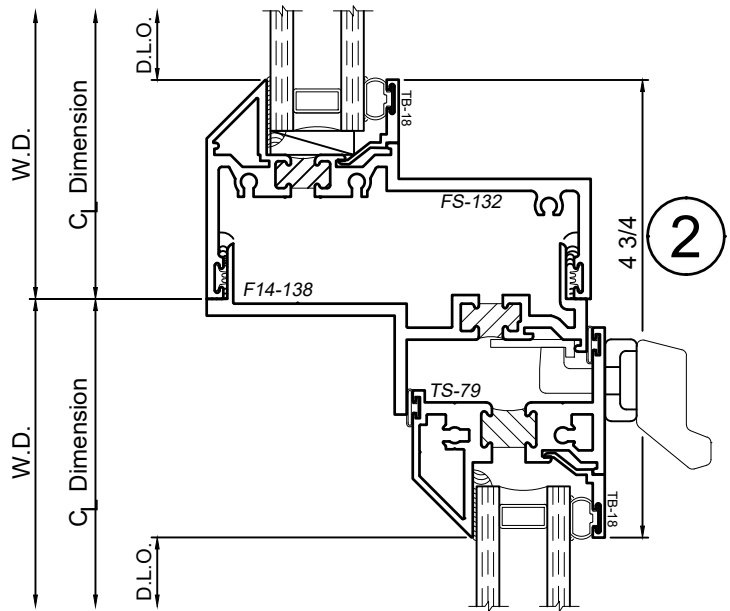

© WINCO WINDOW COMPANY, INC. 2026

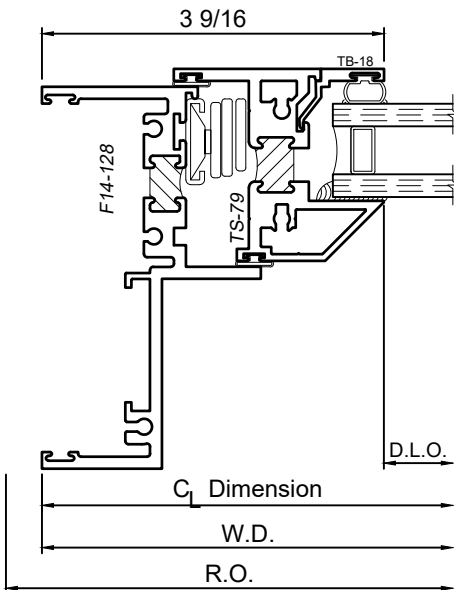

5

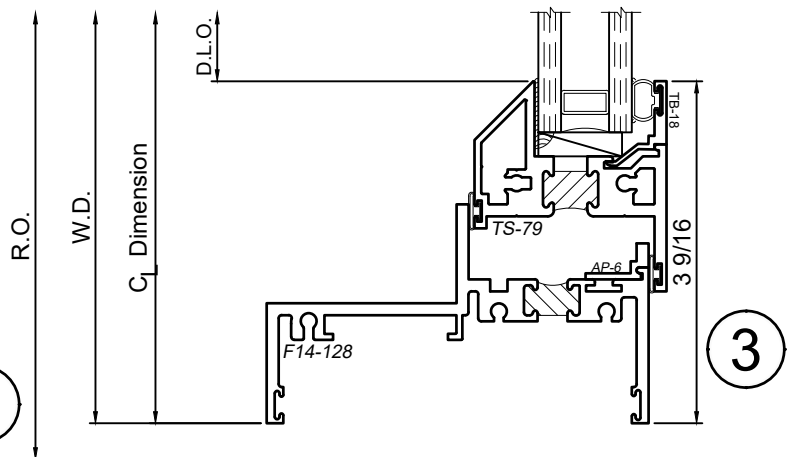

SCALE 6"=1'-0"